

SHAPESHIFTER

"A Richard Belliveau Concept"

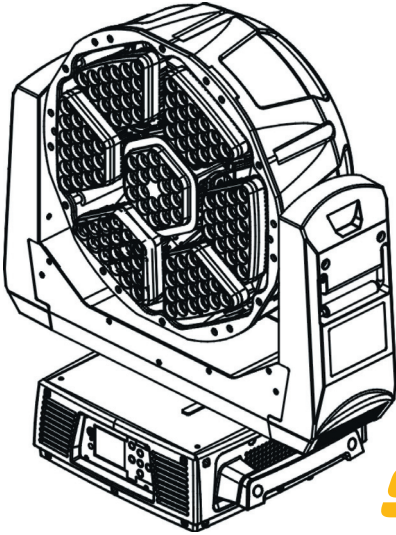

SHAPESHIFTER C2 ***SHAPESHIFTER W2***

User Manual

© Barco Lighting Systems, 2014, All Rights Reserved

Information and specifications in this document are subject to change without notice. Barco Lighting Systems assumes no responsibility or liability for any errors or inaccuracies that may appear in this manual.

Trademarks used in this text:

High End Systems, Wholehog, and Lithopatterns are registered trademarks: and intellaspot, Internal Effects, the High End Systems globe logo, and the Hog logo are trademarks of Barco Lighting Systems, High End Systems, Inc. is a registered trademark. Belden is a registered trademark of Belden, Inc.

Other trademarks and trade names may be used in this document to refer to either the entities claiming the marks and names or their products. High End Systems disclaims any proprietary interest in trademarks and trade names owned by others.

HIGH END SYSTEMS



a Barco company

SHAPESHIFTER C2 and W2 User Manual

Version 1.0

August, 2014

Contact Information

U.S. and the Americas

Sales Department

High End Systems
2105 Gracy Farms Lane
Austin, TX 78758 USA
voice: 512.836.2242
fax: 512.837.5290
Toll Free: 800.890.8989

Customer Service

High End Systems
2105 Gracy Farms Lane
Austin, TX 78758 USA
voice: 800.890.8989
fax: 512.834.9195
toll free: 800.890.8989

World Wide Web:

<http://www.highend.com>

Product Modification Warning

High End Systems products are designed and manufactured to meet the requirements of United States and International safety regulations. Modifications to the product could affect safety and render the product non-compliant to relevant safety standards.

Mise En Garde Contre La Modification Du Produit

Les produits High End Systems sont conçus et fabriqués conformément aux exigences des règlements internationaux de sécurité. Toute modification du produit peut entraîner sa non conformité aux normes de sécurité en vigueur.

Produktmodifikationswarnung

Design und Herstellung von High End Systems entsprechen den Anforderungen der U.S. Amerikanischen und internationalen Sicherheitsvorschriften. Abänderungen dieses Produktes können dessen Sicherheit beeinträchtigen und unter Umständen gegen die diesbezüglichen Sicherheitsnormen verstoßen.

Avvertenza Sulla Modifica Del Prodotto

I prodotti di High End Systems sono stati progettati e fabbricati per soddisfare i requisiti delle normative di sicurezza statunitensi ed internazionali. Qualsiasi modifica al prodotto potrebbe pregiudicare la sicurezza e rendere il prodotto non conforme agli standard di sicurezza pertinenti.

Advertencia De Modificación Del Producto

Los productos de High End Systems están diseñados y fabricados para cumplir los requisitos de las reglamentaciones de seguridad de los Estados Unidos e internacionales. Las modificaciones al producto podrían afectar la seguridad y dejar al producto fuera de conformidad con las normas de seguridad relevantes.

Important Safety Information

Instructions pertaining to continued protection against fire, electric shock, and injury to persons are found throughout this manual. Please read all instructions prior to assembling, mounting, and operating this equipment.

The following international caution and warning symbols appear in margins throughout this manual to highlight messages.



This symbol appears adjacent to Caution messages. Not heeding these messages could result in personal injury and/or damage to equipment.



This symbol appears adjacent to high voltage warning messages. Not heeding these messages could result in serious personal injury.



This symbol cautions against mounting the fixture on or near a flammable surface.



This symbol indicates that, while operating, equipment surfaces may reach very high temperatures. Allow the fixture to cool before handling.

Warranty Information

Limited Warranty

Unless otherwise stated, your product is covered by a one year parts and labor limited warranty. Dichroic filters and LithoPatterns® high resolution glass gobos are not guaranteed against breakage or scratches to coating. It is the owner's responsibility to furnish receipts or invoices for verification of purchase, date, and dealer or distributor. If purchase date cannot be provided, date of manufacture will be used to determine warranty period.

Returning an Item Under Warranty for Repair

It is necessary to obtain a Return Material Authorization (RMA) number from your dealer or point of purchase BEFORE any units are returned for repair. The manufacturer will make the final determination as to whether or not the unit is covered by warranty.

A fixture must be returned in its original packaging. Any other parts returned to High End Systems must be packaged in a suitable manner to ensure the protection of such product unit or parts, and such package shall be clearly and prominently marked to indicate that the package contains returned Product units or parts and with an RMA number. Accompany all returned Product units or parts with a written explanation of the alleged problem or malfunction. Ship returned Product units or parts to: 2105 Gracy Farms Lane, Austin, TX 78758 USA.

Note: Freight Damage Claims are invalid for fixtures shipped in non-factory boxes and packing materials.

Freight

All shipping will be paid by the purchaser. Items under warranty shall have return shipping paid by the manufacturer only in the Continental United States. Under no circumstances will freight collect shipments be accepted. Prepaid shipping does not include rush expediting such as air freight. Air freight can be sent customer collect in the Continental United States.

REPAIR OR REPLACEMENT AS PROVIDED FOR UNDER THIS WARRANTY IS THE EXCLUSIVE REMEDY OF THE CONSUMER. HIGH END SYSTEMS, INC. MAKES NO WARRANTIES, EXPRESS OR IMPLIED, WITH RESPECT TO ANY PRODUCT, AND HIGH END SPECIFICALLY DISCLAIMS ANY WARRANTY OF MERCHANTABILITY OR FITNESS FOR A PARTICULAR PURPOSE. HIGH END SHALL NOT BE LIABLE FOR ANY INDIRECT, INCIDENTAL OR CONSEQUENTIAL DAMAGE, INCLUDING LOST PROFITS, SUSTAINED OR INCURRED IN CONNECTION WITH ANY PRODUCT OR CAUSED BY PRODUCT DEFECTS OR THE PARTIAL OR TOTAL FAILURE OF ANY PRODUCT REGARDLESS OF THE FORM OF ACTION, WHETHER IN CONTRACT, TORT (INCLUDING NEGLIGENCE), STRICT LIABILITY OR OTHERWISE, AND WHETHER OR NOT SUCH DAMAGE WAS FORESEEN OR UNFORESEEN.

Warranty is void if the product is misused, damaged, modified in any way, or for unauthorized repairs or parts. This warranty gives you specific legal rights, and you may also have other rights which vary from state to state.

Patents

This product may use one or more of the following patents: US 4,392,187; US 4,602,321; US 4,688,161; US 4,701,833; US 4,709,311; US 4,779,176; US 4,800,474; US 4,962,687; US 4,972,306; US 4,980,806; US 5,010,459; US 5,031,078; US 5,073,847; US 5,078,039; US 5,186,536; US 5,209,560; US 5,278,742; US 5,282,121; US 5,307,295; US 5,329,431; US 5,331,822; US 5,367,444; US 5,402,326; US 5,414,328; US 5,426,576; US 5,430,629; US 5,432,691; US 5,454,477; US 5,455,748; US 5,502,627; US 5,506,762; US 5,515,254; US 5,537,303; US 5,545,951; US 5,588,021; US 5,590,954; US 5,590,955; US 5,640,061; US 5,647,662; US 5,691,886; US 5,702,082; US 5,728,994; US 5,758,955; US 5,758,956; US 5,769,527; US 5,769,531; US 5,774,273; US 5,788,365; US 5,794,881; US 5,795,058; US 5,798,619; US 5,806,951; US 5,812,596; US 5,823,661; US 5,825,548; US 5,828,485; US 5,829,868; US 5,857,768; US 5,882,107; US 5,921,659; US 5,934,794; US 5,940,204; US 5,945,786; US 5,953,151; US 5,953,152; US 5,969,485; US 5,980,066; US 5,983,280; US 5,984,248; US 5,986,201; US 6,011,662; US 6,029,122; US 6,048,080; US 6,048,081; US 6,054,816; US 6,057,958; US 6,062,706; US 6,079,853; US 6,126,288; US 6,142,652; US 6,142,653; US 6,172,822; US 6,175,771; US 6,188,933; US 6,208,087; US 6,219,093; US 6,220,730; US 6,241,366; US 6,249,091; US 6,255,787; US 6,256,136; US 6,261,636; US 6,278,542; US 6,278,545; US 6,278,563; US 6,288,828; US 6,326,741; US 6,327,103; US 6,331,756; US 6,346,783; US 6,421,165; US 6,430,934; US 6,459,217; US 6,466,357; US 6,502,961; US 6,515,435; US 6,523,353; US 6,536,922; US 6,538,797; US 6,545,586; US 6,549,324; US 6,549,326; US 6,563,520; US 6,565,941; US 6,570,348; US 6,575,577; US 6,578,991; US 6,588,944; US 6,592,480; US 6,597,132; US 6,600,270; US 6,601,974; US 6,605,907; US 6,617,792; US 6,621,239; US 6,622,053; US 6,635,999; US 6,648,286; US 6,664,745; US 6,682,031; US 6,693,392; US 6,696,101; US 6,719,433; US 6,736,528; US 6,771,411; US 6,775,991; US 6,783,251; US 6,801,353; US 6,812,653; US 6,823,119; US 6,865,008; US 6,866,390; US 6,866,402; US 6,866,451; US 6,869,193; US 6,891,656; US 6,894,443; US 6,919,916; US 6,930,456; US 6,934,071; US 6,937,338; US 6,955,435; US 6,969,960; US 6,971,764; US 6,982,529; US 6,988,805; US 6,988,807; US 6,988,817; US 7,000,417; US 7,011,429; US 7,018,047; US 7,020,370; US 7,033,028; US 7,048,838; US 7,055,963; US 7,055,964; US 7,057,797; US 7,073,910; US 7,078,869; US 7,092,098; US 7,119,902; US 7,161,562; US 7,175,317; US 7,181,112; US 7,206,023; US 7,210,798; US D347,113; US D350,408; US D359,574; US D360,404; US D365,165; US D366,712; US D370,080; US D372,550; US D374,439; US D377,338; US D381,740; US D409,771; AT E169413; CA 2142619; CA 2145508; CA 2245842; DE 22588.4-08; DE 621495; DE 655144; DE 69320175.4; DE 69322401.0; DE 69331145.2; DE 69525856.7; DE 69734744.3; DE 797503; DK 0655144; DK 1447702; EP 0475082; EP 0621495; EP 0655144; EP 0662275; EP 0767398; EP 0797503; EP 0969247; EP 1447702; ES 0621495; FR 0621495; FR 0655144; FR 0662275; FR 1447702; GB 2043769B; GB 2055842B; GB 2283808B; GB 2290134B; GB 2291814B; GB 2292530B; GB 2292896B; GB 2294909B; GB 2295058B; GB 2303203B; GB 2306887B; GB 2307036B; GB 2316477B; IE 0621495; IT 034244BE; 2005; IT 0621495; IT 0655144; JP 3495373; JP 3793577; NL 0621495; NL 0797503; NL 0969247; UK 0621495; UK 0655144; UK 0662275; UK 0797503; UK 0969247; UK 1447702;

Table of Contents

SHAPESHIFTER User Manual	i
Contact Information	ii
Product Modification Warning	iii
Important Safety Information	iv
Warranty Information	v
Limited Warranty	v
Returning an Item Under Warranty for Repair	v
Freight	v
Patents	vi

Chapter 1: Product Overview

This chapter describes the features and specifications of the SHAPESHIFTER C2 and SHAPESHIFTER W2 fixtures along with a list of related products and accessories.

Features	1
Operation	2
Specifications	2
Mechanical Specifications	2
Electrical Specifications	3
Environmental Specifications	3
Cables and Connectors	3
Fixture Components	4
Related Products and Accessories	4

Chapter 1: SHAPESHIFTER Setup and Configuration

Installation of your SHAPESHIFTER fixture includes mounting, connecting to power, DMX linking and configuration.

Unpacking the Fixture	5
Pan and Tilt Locking	5
Installing a Power Cord Cap	6
Installing a Line Cord Cap - U.K. Only	6
Vatic Fitter Heads Information - Denmark	6
Mounting the Fixture	7
Mounting the Fixture Upright	7
Truss Mounting	7

Linking SHAPESHIFTER Fixtures	9
Cable Connectors	9
Connecting to the Link	10
Terminating the Link	11
Configuring SHAPESHIFTER for DMX Control	12
Setting a Start Channel in Battery Mode	12
Powering On the Fixture	13
Shutting Down the Fixture	13

Chapter 2: Menu System

This chapter shows you how to access and navigate the onboard Menu system and the options available for each menu with examples.

Menu System Overview	15
Navigation Basics	16
Battery Operation	16
Exiting Battery Mode.....	16
SHAPESHIFTER Menu Map	17
Menu System Options	20
Address Menu	20
Setting a Start Channel.....	20
Determining DMX Start Channel Assignment	21
Information Menu	22
Time Info	22
Values Display	23
Head Temperature.....	23
Software Version	23
Set Menu	24
Status Options	24
Service Setting	25
Display Setting	26
Temp C/F	26
Reset Default.....	26
Test Options Menu	27
Homing the Fixture.....	27
Manual Ctrl.....	27
Calibration.....	28
Preset Menu	28
Battery Menu	28

Chapter 3: Preset Programming

SHAPESHIFTER fixtures can be programmed through the onboard menu system using Preset Programming. This section describes how to program your fixtures for stand-alone operation using the on-board memory in each fixture to create and store scenes.

Preset Programming Overview	29
Navigating to the Preset Menu	29
Master and Slave	30
Preset Menu	31
Playback Settings	31
Automatic Program Run	31
Set to Slave	31
DMX Control	31
Music Control	31
Edit Scenes	32
Edit Scene Parameters	32
Edit Scene Time	32
Set Fade Time	32
Set Input by Out	33
Edit Program	33
Select Program	34
Scenes Input	34

Chapter 4: DMX Programming

You can program SHAPESHIFTER fixtures in terms of color, intensity, and timing and can position the LED modules to form single or multiple beams. This chapter gives a brief overview of DMX programming and describes the parameters.

DMX Programming Overview	35
Full Speed versus MSpeed Control	35
16-bit Functionality	35
DMX Programming Options	35
Programming with a DMX Console	35
SHAPESHIFTER DMX Protocol Options	36
Reduced Protocol Mode	36
SHAPESHIFTER C2 Reduced Protocol	36
SHAPESHIFTER W2 Reduced Protocol	36
Enhanced Protocol Mode	37
SHAPESHIFTER C2 Enhanced Protocol	37
SHAPESHIFTER W2	38

Parameter Descriptions	39
Positioning Parameters	39
Fixture Pan and Tilt	39
Module X and Y Position	39
Color Parameters	40
Shutter Parameters	41
Shutter Function	41
Shutter	41
Dim	41
MSpeed (Motor Speed)	41
Macros	42
Inclusive Macros	42
LED X Y and LED Intensity Macros	42
Control	43
Indigo Highlighter	44
Indigo Highlighter Function	44
Indigo Highlighter Dim	44
 Chapter 5: General Maintenance and Troubleshooting	
<i>This chapter outlines safety and maintenance procedures as well as troubleshooting error messages.</i>	
Safety Considerations	45
Maintenance	45
Cleaning the Fixture	45
Coplaner Alignment	46
Troubleshooting Error Messages	48
 Appendix A: MSpeed Conversion Table	51

Chapter I:

Product Overview

This chapter describes the features and specifications of the SHAPESHIFTER C2 and SHAPESHIFTER W2 fixtures along with a list of related products and accessories.

With technology that combines the output of 63 high-powered LEDs with custom lensing, SHAPESHIFTER C2 and SHAPESHIFTER W2 are the smaller versions of - SHAPESHIFTER C1 (RGB) and SHAPESHIFTER W1 (White). SHAPESHIFTER C2 outputs 12,000 RGB lumens and the W2 45,000 lumens.

Seven independently controlled modules housed in one moving fixture create a multitude of highly defined beams coming together to form a wide range of effects giving the designer the largest palette of creative options available from one fixture. High End Systems also provides Module Macros, custom written to provide the user with a fast and intuitive way to create powerful effects in a very short space of time. These Macros are further enhanced by speed and cross fade controls.

Features

- 63 Cree XPE II LED's
 - C1= 21 Red, 21 Green, 21 Blue.
 - W1= 63 White
- 50,000 hours LED Life
- Custom integrated lensing for high contrast defined beams
- 10 degree beam angle
- Ultra fast Pan and Tilt movement
- Seven discrete LED Modules with individual control
- Six moving modules offering 36 degrees of X and Y movement at high speeds
- Onboard dynamic macros
- Unique Indigo Backlighter LED
- Color LCD menu with battery operation
- Low ambient noise
- RDM compatible
- Touring roadcase

Operation

- Auto-switching power supply
- 100v-240v
- DMX/RDM Connector: 5-pin and 3-pin XLR

Specifications

Mechanical Specifications

Fixture Dimensions: 388mm x 320mm x 479mm (15.3in x 12.6in x 18.9in)

Roadcase Dimensions: 855mm x 555mm x 675mm (33.7in x 21.8in x 26.6in)

Fixture Weight: 20.3 kg (44.7 lbs)

Shipping Weight: 88.35 kg (194.8 lb)

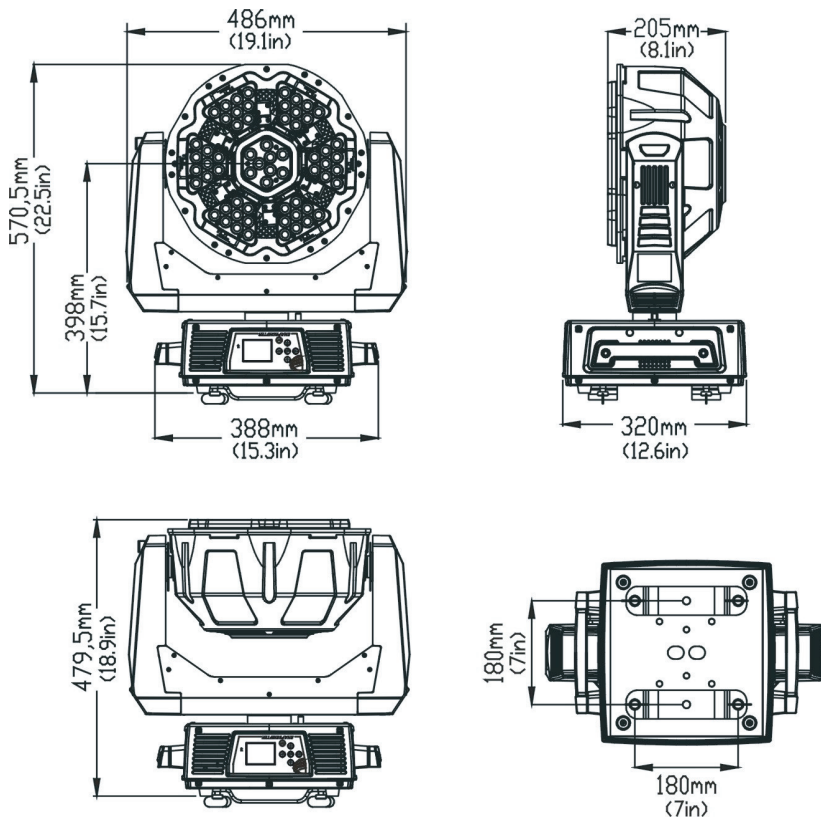

Electrical Specifications

Fixture Rated Power: 300 W

Power consumption: 100V 50 3.5 amps
120V 60 3 amps
240V 50/60 1.5 amps



Warning: Class I equipment - For continued protection against electric shock connect this equipment to an earthed (grounded) power source only.

This equipment for connection to branch circuit having a maximum overload protection of 20 A.

Environmental Specifications

Maximum ambient temperature: 45° C (113° F)

Maximum exterior surface temperature: 110° C (230° F)

Minimum distance to lighted object: 1 m (3.28 ft)

Minimum distance to flammable objects: 1 m (3.28 ft)



Caution: Do not mount on a flammable surface. Not for residential use. Use in dry locations only.



Caution: LED Radiation. Do not stare into beam. Class 2 LED product

Cables and Connectors

Belden® 3107A or equivalent (meets specifications for EIA RS-485 applications) with the following characteristics:

- Two twisted pairs plus a shield
- maximum capacitance between conductors - 30 pF/ft.
- maximum capacitance between conductor and shield - 55 pF/ft.
- maximum resistance of 20Ω / 1000 ft.
- nominal impedance 100-140Ω

Fixture Components

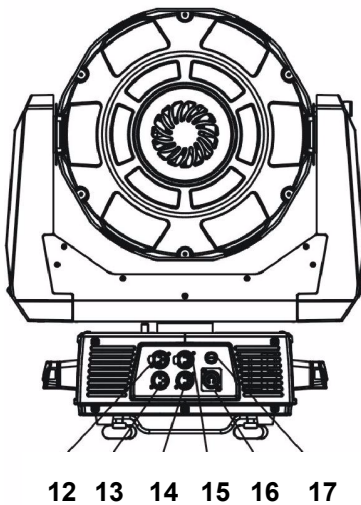
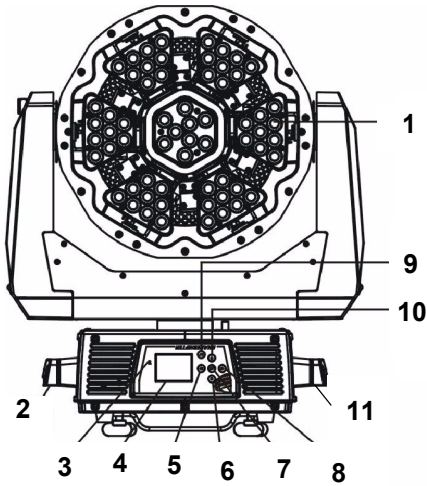

1. Lens
2. Microphone
3. DC Switch
4. Display
5. Right-button
6. Up-button
7. ENTER-button
8. Left-button
9. Mode/Esc-button
10. Down-button
11. Handle
12. 5-pin DMX out
13. 5-pin DMX in
14. 3-pin DMX out
15. 3-pin DMX in
16. Power supply
17. Fuse

Related Products and Accessories

Name	Part Number
Heavy duty 5-pin XLR cable (10')	55050017
Heavy duty 5-pin XLR cable (25')	55050018
Heavy duty 5-pin XLR cable (50')	55050019
Heavy duty 5-pin XLR cable (100')	55050020
Galvanized safety cable	12040001

Chapter I: SHAPESHIFTER

Setup and Configuration

Installation of your SHAPESHIFTER fixture includes mounting, connecting to power, DMX linking and configuration.

Use the following steps to set up and configure your fixture:

- 1. Unpack the fixture.**
- 2. Install power cord cap for your location.**
- 3. Mount the fixture upright or suspended from a standard truss.**
- 4. Connect the fixture to a DMX controller via DMX cabling.**
- 5. Configure the fixture for DMX control.**

Unpacking the Fixture

The SHAPESHIFTER fixture ships in packaging specifically designed to protect the product during transport. When unpacking, inspect the fixture for physical damage to components. High End Systems® assumes no responsibility for products that are damaged during transport. Return a product for repair in its original packaging.

Before sending anything to the factory, call your High End Systems dealer/distributor for a Return Material Authorization (RMA) number. The factory cannot accept any goods shipped without an RMA number.

Pan and Tilt Locking

The SHAPESHIFTER fixture ships with pan and tilt latches locked. You can unlock/adjust these latches to stabilize the fixture for mounting.

Note: *Always disengage Pan and Tilt locks before operating the fixture.*

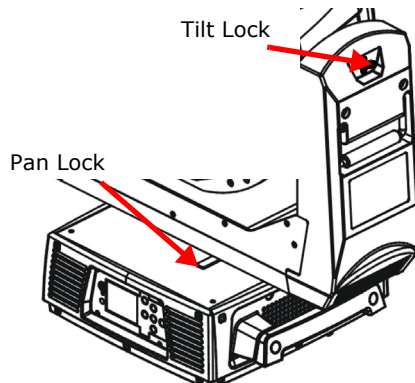

Installing a Power Cord Cap

The power cord for SHAPESHIFTER fixtures ships without a power cord cap. Use the information in this section to install the correct power cord cap for your location.

Because of the variety of power cord caps used worldwide, High End Systems, Inc. cannot make specific recommendations for the power cord cap. Contact a local authority for the type of power cord cap needed. When installing the power cord cap, note that the cores in the mains lead are colored according to the following code:

- green and yellow = earth
- white = neutral
- black = live

Installing a Line Cord Cap - U.K. Only

In the United Kingdom, core colours in the mains lead of this equipment may not correspond with the colored markings identifying the terminals in the fixture's plug. In that case, install a line cord cap in accordance with the following code:

- Connect the green and yellow core to the plug terminal marked with the letter "E," or by the earth symbol  or coloured green, or green and yellow.
- Connect the white core to the terminal marked with the letter "N" or coloured black.
- Connect the black core to the terminal marked with the letter "L" or coloured red.



WARNING:
Class 1 equipment - This equipment must be earthed.

Vatic Fitter Heads Information - Danmark

Advarsel: Beskyttelse mod elektrisk chock.

Vigtigt!

Lederne med gul/groen isolation maa kun tilsluttes en klemme maerket



eller



Mounting the Fixture

You can mount your SHAPESHIFTER fixture suspended from a support system (such as a truss) or freestanding on its base.



WARNING!

Equipment suitable for dry locations only. Do not expose this equipment to rain or moisture.



CAUTION!

SHAPESHIFTER fixtures must be installed and operated by trained personnel only.

Always use a secondary safety cable when mounting this fixture.



Do not mount within .5 meters (1.6 feet) of a flammable object.

Note: Due to the wide variety of possible lighting designs, High End Systems cannot make specific mounting recommendations. Consider the following procedures as suggested guidelines only.

Mounting the Fixture Upright



CAUTION!

Do not mount the fixture upright without the four rubber feet attached.

To mount the fixture upright, place the fixture on a sturdy, stable non-flammable surface that will support more than the 20.3 kg (44.7 lb) weight of the SHAPESHIFTER fixture. If the surface is above floor height, use safety cables to secure the fixture to the surface.

Truss Mounting

When mounting the fixture on a truss or another type of support:

- Verify the truss or support will handle the combined weight of all the devices on the truss.
- Always mount a SHAPESHIFTER fixture using the mounting bracket assembly that shipped with your fixture and a safety cable attached to the fixture's base.



WARNING!

Before mounting, disconnect power to the fixture. If it has been operating, allow the fixture to cool for five minutes before handling.



CAUTION!

Only experienced lighting personnel should attempt to hang a lighting fixture to an appropriate theatrical truss.



WARNING!

In all cases a safety cable should also be fixed between the safety cable mounting holes located at the bottom of the fixture base housing and the truss. Failure to use a safety cable could result in injury or death. High End Systems supplies the proper safety cables and may be contacted for replacements if necessary. For more information go to: www.highend.com/trusshang

Use the following steps to mount a SHAPESHIFTER fixture on a standard truss:

1. Fix the clamp on the bracket by tightening the M12 screw on the bracket to the hole in the center of the bracket.
2. Insert the quick-lock fasteners of the first Omega holder into the respective holes on the bottom of the fixture. Tighten the quick-lock fasteners fully clockwise.
3. Install the second Omega holder.
4. Pull the safety-rope through the holes on the bottom of the base and over the trussing system or a safe fixation spot. Insert the end in the carabine and tighten the safety screw.

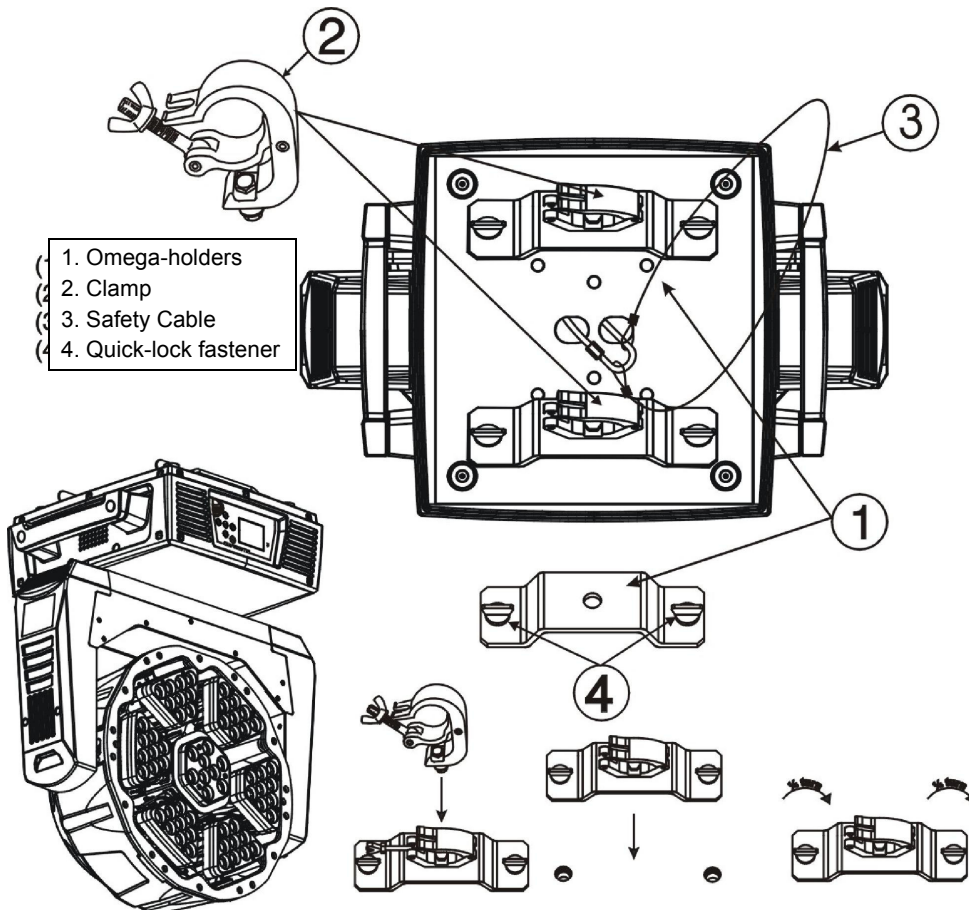

Test each cable with a voltage/ohm meter (VOM) to verify correct polarity and to make sure that the negative and positive pins are not grounded or shorted to the shield or to each other.



CAUTION!

Do not connect anything to the ground lug on the XLR connectors. Do not connect or allow contact between the common (cable shield) and the fixture's chassis ground. Grounding the common could cause a ground loop and/or erratic behavior.

Connecting to the Link

To link one or more fixtures to a DMX controller:

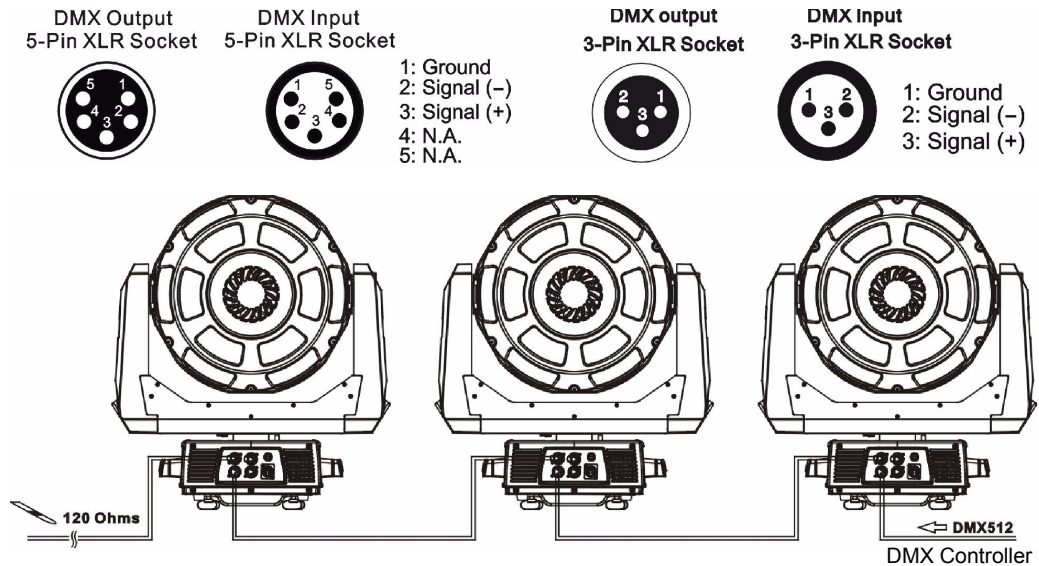

1. Connect the male XLR connector of a DMX Data cable to the controller's DMX Data Out connector.
2. Connect the Data cable's female XLR connector to the Data In connector of the first (or next) fixture on the DMX link.
3. Continue linking the remaining fixtures connecting a cable from the Data Out connector of each fixture to the Data In connector of the next fixture on the link.

For installations where the DMX cable has to run a long distance or is in an electrically noisy environment, a DMX terminator on the last fixture of the link prevents data reflection, which can corrupt the data communication on the link.

Terminating the Link

Terminate the link by installing a 120 ohm, 1/4 watt (minimum) terminator in the fixture's Data Out (female) cable connector in the last fixture on each DMX link.

To construct a terminator:

1. Disassemble a male 3-pin or 5-pin XLR connector.
2. Solder a 120 ohm resistor, minimum of 1/4 watt, between Pin 2 and Pin 3.
3. Reassemble the XLR connector.

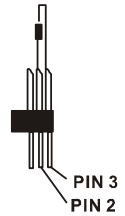
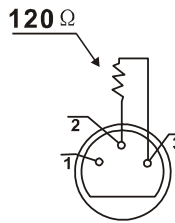

Configuring SHAPESHIFTER for DMX Control



Each SHAPESHIFTER fixture requires a block of 28 channels (Reduced protocol) or 79 channels (Expanded protocol) on a standard DMX512 link. For more information on Start Channels, see *Determining DMX Start Channel Assignment* on page 21. Address your fixture by setting the first channel of the channel range you want to assign this fixture on the link.

Addressing is done for each unit using the fixture's menu system. You can access the menu system is in battery mode to Address the fixture before you mount it or apply power.





Setting a Start Channel in Battery Mode

To address a SHAPESHIFTER fixture in battery mode:

1. Turn on the menu system by pressing and holding the Battery button for two seconds. The display will show the current Function and the Start Channel currently assigned to the fixture.
2. Press the  MODE/ESC button to enter the first level of the menu system. The display will show Address and Info as the first two options in the top menu level.

The red star * indicates the option you are on as you scroll through the levels using the  and  buttons.

The number at the bottom left of the display indicates the Menu Level you are on. Address is the first option on the first level.

3. Press the  **Enter** button to choose **Address**. The currently selected Start Channel is displayed in white.
4. Using the  and  buttons, scroll through other available values (displayed in red) to the desired start channel and press  to select. The newly selected value will now appear in white the next time you enter the menu.
5. The new address will not be stored until the  **Enter** button is pressed.

Note: For a detailed description of the entire menu system, see Chapter 2: Menu System on page 15.



Powering On the Fixture



WARNING:

This equipment is designed for connection to a branch circuit having a maximum overload protection of 20 A.



CAUTION:

Do not power on the fixture until *verifying* that the line cord cap is suitable for the power source in your location. For more information, see *Installing a Power Cord Cap* on page 6.

Disengage Pan and Tilt locks before operating the fixture. For more information, see *Pan and Tilt Locking* on page 5.

Do not unplug motor harnesses while unit is powered.

LED Radiation. Class 2 LED product. Do not stare into beam.

To power on the SHAPESHIFTER fixture, simply connect it to a 100V-240V AC power source.

Once the SHAPESHIFTER fixture is connected to a power source, it automatically begins a homing procedure to verify that fixture components are functioning.

Shutting Down the Fixture

A DMX controller can shut down the fixture remotely with the Shutdown option in the Control Channel or you can simply disconnect from power. The SHAPESHIFTER fixture automatically shuts down in the event of DMX data loss longer than five minutes.

Chapter 2:

Menu System

This chapter shows you how to access and navigate the onboard Menu system and the options available for each menu with examples.



Menu System Overview

The front panel on SHAPESHIFTER fixtures has a full color LCD screen and navigation buttons to display and operate the onboard menu system. You can use the Menu system to perform the following functions at the fixture level:

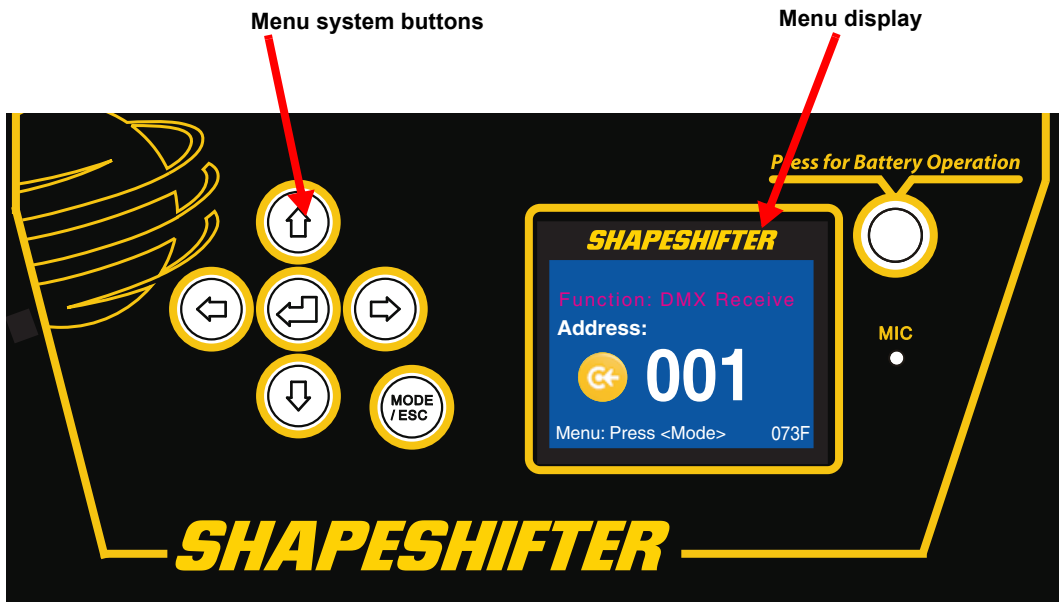
- Assign a DMX start channel
- Access and set fixture options
- View fixture status
- Create preset programs



Navigation Basics

1. Enter the Menu system by pressing the **Mode/Esc**  button for a few seconds until the menu appears.
2. The current option is displayed. Use the  and  buttons to scroll through menu options at the current level. The red star * indicates the current menu.

Note: *At the option or setting level of the menu, the currently selected option is displayed in white. Other options are displayed in red.*

3. Stop at the desired menu and press the **Enter**  button to select. If there is another level of menu choices repeat Steps 2 and 3.

Note: *The new option will not be stored unless the Enter button is pressed.*

4. Stop at the desired option and press the  button to select or press the  button to return to the previous menu level *without changing* the value of an option.

Note: *The currently selected option displays as white. Unselected options display in red.*

5. Continue pressing the  button to move back up levels until exiting the Menu system.

Note: *Some option changes do not take effect until you fully exit the menu system.*

Battery Operation

The SHAPESHIFTER fixture has an internal rechargeable battery that allows menu operation without power applied to the fixture.





To access the display menu in this mode, press the Battery button for two seconds.

Note: *Battery button will not respond if the fixture is receiving power.*

Exiting Battery Mode

The battery mode of the Menu will automatically switch off one minute after the last button press to conserve battery power.



To manually exit the Battery Mode:

1. Push the **Mode/Esc**  button once.
2. Use the  button to scroll to **Battery** and press the  button to select. **Exit Battery** will display in red (not currently selected).
3. Press the  button to select. The display will turn off.

SHAPESHIFTER Menu Map

Menu	Level 2	Level 3	Option/Setting	Description/Notes	
 Address	Set DMX: ###		1-484	Sets the first value of a unique channel range on DMX link.	
 Info	Time Info.	Current Time	####h	Power On running time in hours	
		Ttl Life Hrs	####h	Fixture running time in hours	
		Last Run Hrs	####h	Clears last Run Hours Time	
		Timer PIN	XXX	Sets a Timer Password	
		Clr Last Run		Resets last run time to 0	
	Value Display	None			DMX Control
		All	XXX		Displays parameter's current DMX value
	Head Temp	XXX°C/°F			Displays head temperature in celsius and Fahrenheit
Software Ver	VerX.XXXX			Displays software version	
 Set	Status	No DMX Mode	CloseShutter		Closes shutter when DMX is removed
			Hold		Holds the current Scene
			Auto Program		Reverts to Auto Program
			Music Ctrl		Reverts to Music Control
		Pan Reverse	On		Inverts Pan movement
			Off		Default
		Tilt Reverse	On		Inverts Tilt movement
			Off		Default
		Pan Degree	630/540		Manually sets Pan value in degrees
		Encoders	On		Encoders On
			Off		No encoder feedback
		Mic Sens	0-99		Sets microphone sensitivity as a percentage
		Hibernation	Off		No hibernation
	01M-99M			Set time until hibernation in minutes	
	15M			Default Standby Mode	
	Service PIN	Service PIN	Password = ###		Service Password Default = 050
		RDM PID	#####		Displays RDM PID

Menu	Level 2	Level 3	Option/Setting	Description/Notes	
🔧 Set	Fan <i>Note: HI and LOW settings not available in all software versions.</i>		Auto	Turns fan off and on depending on temperature	
			HI	Runs fan at high speed	
			LOW	Runs fan at low speed	
	Disp. Setting	Shutoff Time		02m-60m	Time until auto shutoff in minutes
			Flip Display	On	Rotates display 180°
		Off		Default display orientation	
		Key Lock	On	Locks key	
	Off		Allows key operation		
	Temp. C/F		Celsius	Selects Temperature Scale	
			Fahrenheit		
	Reset Default		On	Resets factory defaults	
		Off	Maintains changes		
🔍 Test	Home		All	Reset all motors	
			Pan & Tilt	Reset Pan/Tilt motors	
			Others	Reset module motors	
	Test Channel	Auto Program . . . LED 7Y		Parameter test	
	Manual Ctrl	Auto Program		Default	
		Pan ... LED 7Y	0-255	Manually sets a DMX value for any of the individual parameters.	
	Calibration	Password		Set to 050 before calibration	
		Pan	0-255	Fine tunes homing position for individual motors	
		Tilt	0-255		
	🔧 Mode Set	User Mode		Enhanced	Set protocol option
Reduced					

Menu	Level 2	Level 3	Option/Setting	Description/Notes	
 Preset	Playback	DMX Control		Reverts to playback via console	
		Set to Slave	Slave 1	Assigns slave setting	
			Slave 2		
			Slave 3		
		Auto Program	Master	Assigns auto program mode	
			Alone		
		Music Control	Master	Assigns music control mode	
			Alone		
		Select Prog	Prog.Part 1	Program 1 ... Program 10	Selects program to be run in the Program part.
			Prog.Part 2	Program 1 ... Program 10	
			Prog.Part 3	Program 1 ... Program 10	
		Edit Program	Program 1 ... Program 10	Program Test	Runs the program as edited
	Step 01=SCxxx ... Step 64=SCxxx			Chooses a scene for each step in the selected program	
	End			Save and exit	
	Edit Scenes	Edit Scene 001 ... Edit Scene 250	Pan ... Indigo Dim	Allows you to set a DMX value for any of the 21 parameters. (see <i>DMX Programming</i> on page 35)	
			Fade Time	Lets you set a fade time value from 000–255	
			Scene Time	Lets you set a scene time from 00.2s–99.9s	
			Input by Out	Allows you to capture DMX values for all parameters into a scene	
	Scenes Input	x x - x x		Automated scene recording	
 Battery <i>Note: This menu only appears when you are in battery mode.</i>			Exit Battery	Exits the battery mode and shuts off the display.	

Menu System Options

The following sections describe and give examples for selecting and/or setting available fixture configuration options.







Address Menu

Address is the top level menu selection used to set the fixture's DMX start channel. You can address the fixture before applying power in the battery mode or in normal mode after you power up the fixture.

Note: *The last valid Start channel for a SHAPESHIFTER fixture is 485 (Reduced Protocol) or 434 (Enhanced Protocol).*

Setting a Start Channel

To address a SHAPESHIFTER fixture in battery mode:

1. Turn on the menu system by pressing and holding the Battery button for two seconds. The display will show the current Function and Start Channel assigned to the fixture.
2. Press the  MODE/ESC button to enter the first level of the menu system. The display will show Address and Info as the first two options in the top menu level.
The red star * indicates the current menu as you scroll through the level using the   buttons.
The number at the bottom left of the display indicates the Menu Level you are on. Address is the first option on the first level.
3. Press the  **Enter** button to choose **Address**. The currently selected Start Channel is displayed in white.
4. Use the   buttons to scroll to the desired start channel and press  to select.



Determining DMX Start Channel Assignment

There are 512 available channels on each DMX link divided among all the devices in a particular link. A fixture must have a unique Start channel number in order to respond independently to controller commands.

To determine each fixture's DMX start channel in a link, identify the channel range of every fixture on the link. Channel range is the number of consecutive channels a fixture requires. Each SHAPESHIFTER fixture requires a block of 28 consecutive channels on a 512-Channel DMX link for Reduced protocol user mode or 79 channels for Enhanced protocol. The Start channel is the first number of a fixture's channel range.

When setting the Start channel on a fixture, remember:

- A fixture's physical location on the link does not have to coincide with the order of channel range assignments in the link.
- The fixture's channel range must not overlap any other device's channel range on the link. When two devices on the same DMX link have overlapping channel ranges, one or both devices will be disabled or behave erratically. The single exception would be if two or more fixtures need to respond to controller commands in exactly the same way. In that case, those fixtures must be the same type (for example two SHAPESHIFTER fixtures) and must share the *entire* channel range.

The notes in the following table show the various considerations in determining valid Start Channels for fixtures on a 512 DMX link.





Fixture Rig Position	Fixture Type	DMX Channel Footprint	DMX Start Channel	Channel Range	Notes
First	SHAPESHIFTER C1 (Reduced Protocol)	28 channels	C001	1-28	The Start channel is the first channel in a consecutive block of channels assigned to a fixture.
Third	SHAPESHIFTER W1 (Enhanced Protocol)	79 channels	C029	29-108	Fixture can be assigned the second block of DMX channels without being the second fixture on the rig.
Second	Technospot	37 channels	C109	109-145	Avoid overlapping channels with other fixtures
Fourth	Studio Spot	18 channels	C400	401-418	Every channel in the link does not need to be assigned.

Information Menu

The Information menu displays current fixture information such as internal temperature, total fixture hours, software version, and DMX values for each of the fixture's parameters.

Fixture hours resets are executed in the Information Menu.







To enter the Information Menu:





1. Press the  MODE/ESC button to enter the first level of the menu system. The display will show **Address** and **Info** as the first two options in the top menu level.
2. Using the   buttons, scroll to **Info**.
3. Press the  button to select.

Time Info

The Time Info menu displays and resets certain time functions.

To view/reset time values or set passwords:

1. Navigate to and select **Info** menu as shown above. Time Info is the first option you will view.
2. Using the   buttons, scroll to **Time Info** and press the  button to select.
3. Using the   buttons, scroll to any of the following menu options and press the  button to select.







Current Time	Power On running time in hours
Ttl Life Hrs	Fixture running time in hours
Last Run Hrs	Fixture last times clear
Timer PIN	Use   buttons to set a Timer Password (Default PIN = 038)
Clr Last Run	OFF is the default value. Use   buttons to scroll to ON and select to reset to 0

4. Press the  button to confirm or  to return to previous menu level.

Values Display

This menu option lets you view the current DMX value for each of the fixture's parameters.



To view DMX values by Parameter:

1. Navigate to and select the **Info** menu as shown on *page 22*.
2. Using the   buttons, scroll to **Values Display** and press the  button to select.
3. Using the   buttons, scroll to any of the DMX parameters in the SHAPESHIFTER protocol and press the  button to view its current DMX decimal value.

Head Temperature

The SHAPESHIFTER fixture contains temperature sensors on each LED module that monitor the air temperature of the LED boards.



To view temperature:

1. Navigate to and select the **Info** menu as shown on *page 22*.
2. Using the   buttons, scroll to **Head Temp** and press the  button to select.
The temperature will be displayed in degrees Celsius or Fahrenheit depending on which scale is currently selected in the **Set** menu, see *Temp C/F* on *page 26*.

Software Version

This Info menu option displays the current fixture software loaded on the unit. Software versions can vary even between units purchased at the same time.

To view fixture:

1. Navigate to and select the **Info** menu as shown on *page 22*.
2. Using the   buttons, scroll to **Software Ver** and press the  button to select.



Set Menu

The Set Parameters menu lets you configure your fixture's motion, display, and data source settings.

To enter the Set menu:











1. Press the  MODE/ESC button to enter the first level of the menu system. The display will show **Address** and **Info** as the first two options in the top menu level.

*The red star * indicates the current option.*

2. Using the   buttons, scroll to **Set**.
3. Press the  button to select.

Status Options

This menu lets you configure various fixture functions. To set a status option:

1. Navigate to and select the **Set** menu as shown above.
2. Using the   buttons, scroll to **Status** and press the  button to select.
3. Using the   buttons, scroll to one of the status options below and press the  button to select.
4. Using the   buttons, scroll to the desired setting and press  to select or  to return to the last menu level.

No DMX Mode

This option determines the fixture state after the DMX signal is removed. The Default setting is

Hold : You can choose from the following options:

CloseShutter: Closes shutter when DMX is removed

Hold: Holds the current values for all parameters

Auto Program: Reverts to Auto Program Playback

Music Ctrl: Reverts to Music Control Playback

Pan Reverse

This menu option inverts the direction of the pan motor to coordinate movements between fixtures mounted opposite each other horizontally.

The default setting is **Off**. Select **On** to invert the fixture's Pan motion.

Tilt Reverse

This menu option inverts the direction of the tilt motor to coordinate movements between fixtures on a link facing each other vertically.

The default setting is **Off**. Select **On** to invert the fixture's Tilt motion.

Pan Degree

The standard pan range of a SHAPESHIFTER fixture is 0–540°. This option lets you expand the pan range to an upper limit of 630°.

To expand the pan range, scroll from the default option of **540** to **630** and press the  button to select.

Encoders

Encoders maintain the Pan and Tilt position of the fixture, but may need to be disabled to perform certain test and maintenance procedures. The default setting is **On**. To disable encoders, select the **Off** option.

Pan/Tilt Speed

This options adjusts the maximum movement speed of the pan and tilt parameters. The **Speed 1** option is the default normal movement speed. **Speed 2**, **Speed 3**, and **Speed 4** options are progressively slower maximum movement speeds.

Mic Sensitivity

You can adjust the input level for the internal microphone by setting this option from **0% –99%**. The Default value is **70%**.

Hibernation (Standby Mode)

This menu option determines how the fixture will react in the event of DMX data loss.









Turn Hibernation off to keep the shutter open until shutdown by selecting **Off**.

Scroll to any value from **01M – 99M** to set the number of minutes after data loss before closing the shutter. The default setting is **15M**.

Service Setting

Two options for service setting allow you to set a **Service PIN** or a **RDM PID** code.

To change the Service PIN:









1. Navigate to and select the **Set** menu as shown on *page 24*.
2. Using the   buttons, scroll to **Status** and press the  button to select.
3. Using the   buttons, scroll to **Service PIN** and press the  button to select. The current password will be displayed. The default is **Password = 050**.
4. Using the   buttons, scroll to a 3-digit number and press the  button to select as the new service password.

Note: *A service password must be set before you can enter a six digit RDM PID number.*

Display Setting

This **Set** option lets you control how the display functions.

To select the Display Setting menu

1. Navigate to and select the **Set** menu as shown on *page 24*.
2. Using the   buttons, scroll to **Display Setting** and press the  button to select.
3. Using the   buttons, scroll to one of the following options below and press the  button to select.
4. Using the   buttons, scroll to one of the following options and press the  button to select.

Shutoff Time

This option lets you determine when the display automatically shuts off after the last button push. You can choose a delay from **02 – 60** minutes. The default delay setting is **02** minutes.

Flip Display

Use this option to rotate the display 180° when that orientation is easier to view. **Off** is the default setting. Select **On** to flip the display. Note that this option only takes effect once you exit the menu system by pressing the  MODE/ESC button.

Key Lock

This display setting lets you activate a key lock. **Off** is the default. Select **On** to activate the key lock and then press and hold the  MODE/ESC button for 2 seconds when you want to unlock the menu. When this function is activated, the keys will lock automatically after exiting the edit mode for 15 seconds.

Temp C/F







This option sets the temperature scale to **Celsius** or **Fahrenheit**. Celsius is the default setting.

Reset Default

This **Set** option lets you return all factory options. The default setting is **Off**. SHAPESHIFTER fixtures ship with the following factory default settings:

Pan Reverse = Disabled	Encoders = On	Flip display = Off
Tilt Reverse = Disabled	No DMX Mode = Hold	Keylock = Off
Pan Degree = 540	Temp C/F = Celsius	Microphone Sensitivity = 70%
Hibernation = 15M	Movement Speed = Speed 1	Shutoff Time = 2 minutes

To reset defaults:

1. Navigate to and select the **Set** menu as shown on *page 24*.
2. Using the   buttons, scroll to **Reset Defaults** and press the  button to select.
3. Using the   buttons, scroll to **On** and press the  button to select.

Test Options Menu

This menu lets you manually Home the fixture and change DMX values for parameters.

To Enter the **Test Options** Menu:

1. Press the  MODE/ESC button to enter the first level of the menu system. The display will show **Address** and **Info** as the first two options in the top menu level.

*The red star * indicates the current option.*

2. Using the   buttons, scroll to **Test**.
3. Press the  button to select.

Homing the Fixture





The SHAPESHIFTER fixture automatically homes whenever it is connected to power. The following options are available to let you manually home all the fixture motors or motors for specific functions:

All: Reset all motors

Pan & Tilt: Reset Pan/Tilt motors

Others: Reset LED module motors









For example, to manually home the LED module motors:

1. Navigate to and select the **Test** menu as shown above.
2. Using the  buttons, scroll to **Home** and press the  button to select.
3. Using the   buttons, scroll to **Others** and press the  button to select. The fixture automatically begins homing the motors for the outer ring of LED modules.

Manual Ctrl

This test option lets you manually set a DMX value for any of the SHAPESHIFTER fixture's DMX channels. **Auto Program** is the default setting. Refer to *Chapter 5: DMX Programming* on page 35 for specific information on DMX value settings for each parameter.







For example, to change the **Mix Color Function** from **RGB** to **CMY**:

1. Navigate to and select the **Test** menu as shown above.
2. Using the   buttons, scroll to **Manual Ctrl** and press the  button to select.
3. Using the   buttons, scroll to **Mix Color** and press the  button to select.
4. Using the   buttons, scroll to a value from **16-31** and press the  button to select the CMY color function.

Calibration

This **Test** menu option lets you fine tune the home position for Pan and Tilt motors.

To calibrate **Pan** after homing:





1. Navigate to and select the **Test** menu as shown above.
2. Using the   buttons, scroll to **Calibration** and press the  button to select.
3. Using the   buttons, scroll to **Pan** and press the  button to select.

Preset Menu

The preset menu allows you to program scenes directly to the fixture. The options for designing and playing back presets are described in *Chapter 3: Preset Programming* on page 29.

Battery Menu

This menu is only available when you are currently operating in Battery Mode. Use the following steps to return to normal power mode:

1. Push the **Mode/Esc**  button.
2. Use the  button to scroll to **Battery** and press the  button to select. **Exit Battery** will display in red (not currently selected).
3. Press the  button to select. The display will turn off.

Chapter 3:

Preset Programming

SHAPESHIFTER fixtures can be programmed through the onboard menu system using Preset Programming. This section describes how to program your fixtures for stand-alone operation using the on-board memory in each fixture to create and store scenes.

Preset Programming Overview

Presets are built from combining scenes into programs and then assigning the programs to Program Partitions for playback by a fixture designated as the Master and, if desired, groups of slave fixtures assigned to a Program Partition. SHAPESHIFTER fixtures ship with factory programmed scenes and programs ready for you to use or edit.

Creating presets consists of performing the following steps:

- **Designating a fixture as the Master**
- **Selecting/Editing Scenes**
- **Sequencing Scenes into Programs**
- **Sequencing Programs into Program Partitions**
- **Configuring slave fixtures on the link to playback a Program Partition from the master**

Navigating to the Preset Menu

To enter the Preset Menu:

1. Press the  MODE/ESC button to enter the first level of the menu system. The display will show **Address** and **Info** as the first two options in the top menu level.

The red star * indicates the current menu.

2. Using the   buttons, scroll to **Preset**.
3. Press the  button to select.

Master and Slave

The following example shows the relationship between scenes, programs and partitions programmed on the Master and how slave groups are assigned.

- Groups of scenes are edited into Programs 1– 6 on the fixture designated as Master
- Program 2 is assigned to Part 1
- Program 4 is assigned to Part 2
- Program 6 is assigned to Part 3
- Fixtures assigned as Slave 1 playback Part 1
- Fixtures assigned as Slave 2 playback Part 2
- Fixtures assigned as Slave 3 playback Part 3

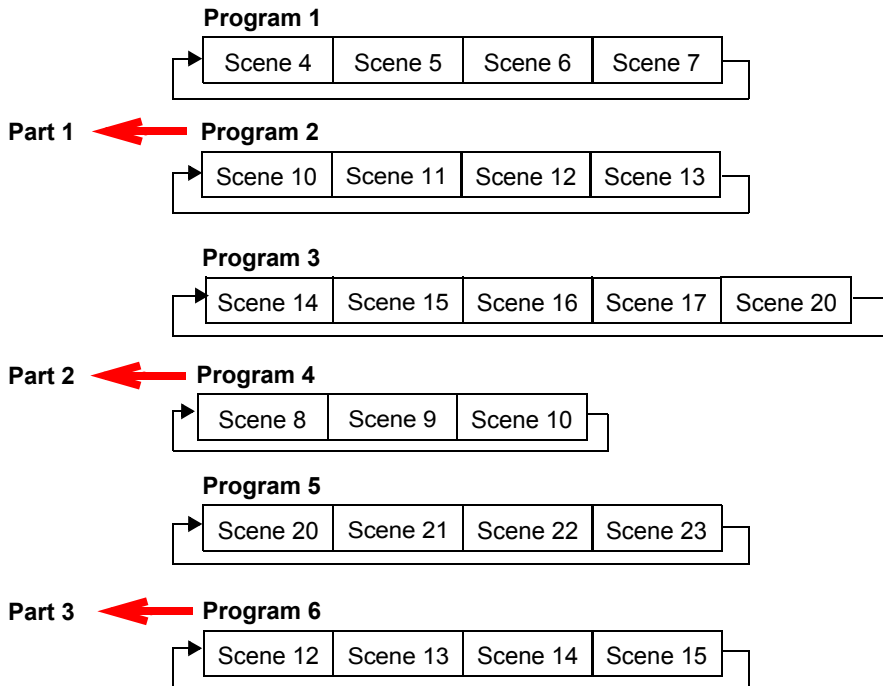

Preset Menu

Playback Settings









Preset programming requires one fixture to act as the Master. All other SHAPESHIFTER fixtures on the link can then be set as slaves to playback the Master presets. Slave fixtures receive all their preset parameter and timing information from the master fixture.

Playback settings designate a fixture as a master or a slave and also allow you to revert from Auto Programming to DMX control from a console or set a fixture in Master or standalone mode for audio control.

Automatic Program Run

This Playback option lets you designate a fixture to playback in Standalone mode or as a Master. **Alone** is the default setting.









To designate a fixture as a Master:

1. Navigate to and select the **Preset** menu as shown on *page 31*.
2. Use the   buttons to scroll to **Playback** menu and press  to select.
3. Use the   buttons to scroll to **Auto Program** menu and press  to select.
4. Use the   buttons to scroll to **Master** and press  to select. Your choice will be shown in the display.

Set to Slave

After a preset program is defined on a Master fixture, other SHAPESHIFTER fixtures on the same DMX link can be designated slaves to playback Program Part 1, 2 or 3 as defined on the Master fixture, see *Select Program* on page 34.

To designate a fixture as a Slave:

1. Navigate to and select the **Preset** menu as shown on *page 31*.
2. Use the   buttons to scroll to **Playback** menu and press  to select.
3. Use the   buttons to scroll to **Set To Slave** menu and press  to select.
4. Use the   buttons to scroll to **Slave1**, **Slave2**, or **Slave3** option and press  to select. Your choice will be shown in the display.

DMX Control

Selecting this option reverts the function from **Auto Program** (Preset Programming) to **DMX Receive** (console control). Selecting this option will take you back to the menu startup screen where **DMX Receive** will be displayed as the currently selected function.

Music Control

This Playback option lets you designate a fixture to playback scenes based on audio triggers detected by the internal microphone in stand alone or as a Master. **Alone** is the default setting.

Edit Scenes













A parameter is a fixture attribute that can be controlled to modify the light beam in terms of color, beam quality and pattern, intensity, or focus (position). DMX programming assigns a DMX value to each of the fixture's parameters. A *scene* is one combination of parameter settings.

SHAPESHIFTER fixtures provide 250 pre-programmed scenes you can use or edit to build a preset program. The first 64 scenes have factory created settings which can be edited as desired.

Edit Scene Parameters

The **Edit Scenes** option lets you select a DMX value for any of the 35 parameters in the SHAPESHIFTER DMX protocol.

To edit the DMX parameters in a scene:

1. Navigate to and select the **Preset** menu as shown on *page 31*.
2. Use the   buttons to scroll to the **Edit Scenes** option and press  to select.
3. Use the   buttons to scroll to the Scene number you wish to build on from 1-250 and press  to select.
4. Use the   buttons to scroll to the parameter you wish to edit (**Pan, Tilt, MSpeed, Color Wheel**, etc.) and press  to select.
5. Use the   buttons to scroll to a new DMX value for the parameter you have selected and press  to select.

This takes you back to parameter options. Continue through all parameters until your desired look is complete. See *Chapter 5: DMX Programming* on page 35 to find parameter values for the option you want to assign.

6. When you are finished selecting all parameter values for a particular Scene, press the  button to return to the **Preset** level menu.

Edit Scene Time











This Scene Edit option lets you set the scene time in seconds from **00.2s–99.9s**. The default value is **00.3s**. This value determines how long the scene will play before the next scene is triggered.

Set Fade Time

This Scene Edit option lets you set a fade time value from **000–255**. This value determines the crossfade time applied to parameters once the scene is triggered.

Set Input by Out













This Scene Edit option allows you to capture the parameter values for a scene from DMX input into the fixture. Once you create a look from a DMX console do the following:

1. Navigate to and select the **Preset** menu as shown on *page 31*.
2. Use the   buttons to scroll to the **Edit Scenes** option and press  to select.
3. Use the   buttons to scroll to the Scene number you wish to build on from 1-250 and press  to select.
4. Use the   button to scroll to the **Input by Out** and press  to select.
5. The scene will record the current parameter values being input via DMX.
6. When you are finished capturing DMX into a scene, press  to return to the main menu.

Edit Program

This preset menu option lets you select from 10 factory set programs to edit. You can set up to 64 **Scenes** in a sequence of **Steps** for each program. You can also test the program at any time by selecting **Program Test** to playback the program as it is currently defined.

To edit a program:























1. Navigate to and select the **Preset** menu as shown on *page 31*.
2. Use the   buttons to scroll to **Edit Prog.** menu and press  to select.
3. Use the   buttons to scroll to a program from **Program 1–Program 10** and press  to select.
4. Use the   buttons to scroll to the Step in the program you want to edit from **Step 1** to **Step 64** and press  to select. The display will show which scene is currently assigned to that step.
5. Use the   buttons to scroll to the scene you want to assign to the step and press  to select.
6. When you have assigned all the steps you want, select End and press  to save the program.

Select Program

This preset option lets you assign a Preset Program to one of three Program Partitions. A fixture assigned as a Slave can playback any Program Partition defined by the Master fixture.







Note: *The Master fixture can only playback Program Partition 1*

To assign a program to each Program Partition:

1. Navigate to and select the **Preset** menu as shown on *page 31*.
2. Use the   buttons to scroll to **Select Prog** menu and press  to select. Each Program Part, has 10 preset programs.
3. Use the   buttons to scroll to **Prog. Part 1** and press  to select.
4. Use the   buttons to scroll to a program from **Program 1–Program 10** and press  to select the program you want to include in the Program Part.
5. Use the   buttons to scroll to **Prog. Part 2** and press  to select.
6. Use the   buttons to scroll to a program from **Program 1–Program 10** and press  to select the program you want to include in the Program Part.
7. Use the   buttons to scroll to **Prog. Part 3** and press  to select.
8. Use the   buttons to scroll to a program from **Program 1–Program 10** and press  to select the program you want to include in the Program Part.
9. Press the  button to return to the main menu.

Scenes Input

This function allows you to capture multiple scenes from DMX values input to the fixture. You first define the number of scenes to capture and then each time a DMX value changes, a different scene will be captured.

1. Navigate to and select the **Preset** menu as shown on *page 49*.
2. Use the   buttons to scroll to the **Scenes Input** option and press  to select.
3. Use the   buttons to set the starting scene number.
4. Use the   buttons to set the ending scene number. With each change of any DMX value, the capturing scene will advance to the next one in the range.
5. When all scenes have been recorded, the scenes input menu will automatically exit.

Note: *During Scenes Input recording, the SHAPESHIFTER does not playback the DMX input, it only captures it. You must edit or playback the scenes after recording to see the results. It is best to prepare the scenes on a DMX controller with a zero crossfade for all parameters between each step. Remember any change of a DMX value will advance to the next scene to capture.*

Chapter 4:

DMX Programming

You can program SHAPESHIFTER fixtures in terms of color, intensity, and timing and can position the LED modules to form single or multiple beams. This chapter gives a brief overview of DMX programming and describes the parameters.

DMX Programming Overview

A parameter is a fixture attribute that can be controlled to modify the light beam in terms of color, beam quality and pattern, intensity, or focus (position). DMX programming assigns a DMX value to each of the fixture's parameters. A *scene* is one combination of parameter settings. Scenes are the building blocks for show creation.

Full Speed versus MSpeed Control

Some parameters can be set to operate at full speed or MSpeed (motor speed). Full speed operations are completed in the shortest length of time after the motor starts moving. With MSpeed control, change occurs smoothly over the entire MSpeed time value selected. For example, if you select an MSpeed time of 30 seconds, the motor will gradually change position until it reaches its new destination at the end of 30 seconds. SHAPESHIFTER fixtures allow optional MSpeed control for pan and tilt movement parameters.

16-bit Functionality

Several parameters use two channels to provide 16-bit control for very fine adjustment capabilities.

DMX Programming Options

Using a DMX controller, you can program an unlimited number of looks and retain direct control over the SHAPESHIFTER fixture at all times. SHAPESHIFTER fixtures also allow Preset programming through the fixture menu system, see *Chapter 5: Preset Programming* on page 47.

Programming with a DMX Console

Hog® 4, Road Hog® 4, Full Boar 4, and Hedge Hog lighting consoles; and Hog® 4PC software are available from High End Systems to control SHAPESHIFTER fixtures (see *Related Products and Accessories* on page 5). For information on whether your DMX controller supports SHAPESHIFTER fixtures, contact the controller's vendor. For information on operating your fixture with a controller (or control device such as DMX control software), consult the documentation provided with the controller.

SHAPESHIFTER DMX Protocol Options

Both SHAPESHIFTER C1 and M1 models have Reduced and Enhanced protocol options.

The Reduced Protocol option uses 28 channels of a standard DMX512 link to control Position, Color mixing, Module movement, Macros, Dimming, Shutter, MSpeed, and the Indigo Highlighter system. All modules are controlled as a unit. SHAPESHIFTER W1 models have all white LEDs so color mixing functions actually refer to changes in the “white” intensity for groups of LEDs on an LED module.

In addition to all the functions of the Reduced protocol, Enhanced protocol mode adds individual control of each of the seven LED modules.

Reduced Protocol Mode

SHAPESHIFTER C2 Reduced Protocol

Chan	Function	Chan	Function	Chan	Function
1	Pan	11	Dim	21	LED Intensity Macro Speed
2		12		22	LED Intensity Macro XFade
3	Tilt	13	MSpeed	23	Control
4		14	Inclusive Macro	24	Indigo Highlighter Function
5	Master LED Function	15	Inclusive Macro Speed	25	Indigo Highlighter Dim
6	LED X	16	Inclusive Macro X Fade	26	LED Red
7	LED y	17	LED XY Macro	27	LED Green
8	Mix Color Function	18	LED XY Macro Speed	28	LED Blue
9	Shutter/LED Functions	19	LED XY Macro XFade		
10	Shutter	20	LED Intensity Macro		

SHAPESHIFTER W2 Reduced Protocol

Chan	Function	Chan	Function	Chan	Function
1	Pan	11	Dim	21	LED Intensity Macro Speed
2		12		22	LED Intensity Macro XFade
3	Tilt	13	MSpeed	23	Control
4		14	Inclusive Macro	24	Indigo Highlighter Function
5	Master LED Function	15	Inclusive Macro Speed	25	Indigo Highlighter Dim
6	LED X	16	Inclusive Macro X Fade	26	LED White 1
7	LED y	17	LED XY Macro	27	LED White 2
8	Mix Color Function	18	LED XY Macro Speed	28	LED White 3
9	Shutter/LED Functions	19	LED XY Macro XFade		
10	Shutter	20	LED Intensity Macro		

Enhanced Protocol Mode

SHAPESHIFTER C2 Enhanced Protocol

Chan	Function	Chan	Function	Chan	Function
1	Pan	27	LED1 Green	53	LED4 Function
2		28	LED1 Blue	54	LED4 Dim
3	Tilt	29	LED1 Function	55	
4		30	LED1 Dim	56	LED5 X
5	Master LED Function	31		57	LED5 Y
6	LED X	32	LED2 X	58	LED5 Red
7	LED y	33	LED2 Y	59	LED5 Green
8	Mix Color Function	34	LED2 Red	60	LED5 Blue
9	Shutter/LED Functions	35	LED2 Green	61	LED5 Function
10	Shutter	36	LED2 Blue	62	LED5 Dim
11	Dim	37	LED2 Function	63	
12		38	LED2 Dim	64	LED6 X
13	MSpeed	39		65	LED6 Y
14	Inclusive Macro	40	LED3 X	66	LED6 Red
15	Inclusive Macro Speed	41	LED3 Y	67	LED6 Green
16	Inclusive Macro X Fade	42	LED3 Red	68	LED6 Blue
17	LED XY Macro	43	LED3 Green	69	LED6 Function
18	LED XY Macro Speed	44	LED3 Blue	70	LED6 Dim
19	LED XY Macro XFade	45	LED3 Function	71	
20	LED Intensity Macro	46	LED3 Dim	72	LED7 X
21	LED Intensity Macro Speed	47		73	LED7 Y
22	LED Intensity Macro XFade	48	LED4 X	74	LED7 Red
23	Control	49	LED4 Y	75	LED7 Green
24	Indigo Highlighter Function	50	LED4 Red	76	LED7 Blue
25	Indigo Highlighter Dim	51	LED4 Green	77	LED7 Function
26	LED1 Red	52	LED4 Blue	78	LED7 Dim
				79	

SHAPESHIFTER W2

Chan	Function	Chan	Function	Chan	Function
1	Pan	27	LED1 White 2	53	LED4 Function
2		28	LED1 White 3	54	LED4 Dim
3	Tilt	29	LED1 Function	55	
4		30	LED1 Dim	56	LED5 X
5	Master LED X/Y Function	31		57	LED5 Y
6	LED X	32	LED2 X	58	LED5 White 1
7	LED y	33	LED2 Y	59	LED5 White 2
8	Mix Color Function	34	LED2 White 1	60	LED5 White 3
9	Shutter/LED Functions	35	LED2 White 2	61	LED5 Function
10	Shutter	36	LED2 White 3	62	LED5 Dim
11	Dim	37	LED2 Function	63	
12		38	LED2 Dim	64	LED6 X
13	MSpeed	39		65	LED6 Y
14	Inclusive Macro	40	LED3 X	66	LED6 White 1
15	Inclusive Macro Speed	41	LED3 Y	67	LED6 White 2
16	Inclusive Macro X Fade	42	LED3 White 1	68	LED6 White 3
17	LED XY Macro	43	LED3 White 1	69	LED6 Function
18	LED XY Macro Speed	44	LED3 White 3	70	LED6 Dim
19	LED XY Macro XFade	45	LED3 Function	71	
20	LED Intensity Macro	46	LED3 Dim	72	LED7 X
21	LED Intensity Macro Speed	47		73	LED7 Y
22	LED Intensity Macro XFade	48	LED4 X	74	LED7 White 1
23	Control	49	LED4 Y	75	LED7 White 2
24	Indigo Highlighter Function	50	LED4 White 1	76	LED7 White 3
25	Indigo Highlighter Dim	51	LED4 White 2	77	LED7 Function
26	LED1 White 1	52	LED4 White 3	78	LED7 Dim
				79	

Parameter Descriptions

Individual parameters are described in the following sections.

Note: *All DMX values indicated in the detailed parameter descriptions are in decimal units.*

Positioning Parameters

Fixture Pan and Tilt

The SHAPESHIFTER fixture has a 630° pan range and a 270° tilt range. Two DMX channels provide 16-bit adjustment to a fraction of a degree for pan and tilt position.

An MSpeed function is available for **Pan** and **Tilt** parameters when the MSpeed parameter. For information on implementing MSpeed, see *MSpeed (Motor Speed)* on page 41.

Note: *Optical encoders for pan and tilt instantly correct the fixture's position if the fixture is jarred from its programmed position. If a physical obstruction prevents the fixture from correcting its position, the fixture "times out" to prevent wear on the motors. If the fixture has timed out, remove the obstruction and home the fixture to return it to normal operation.*

Module X and Y Position

In addition to fixture positioning, you can control the six outer LED modules' positioning. Each outer modules is capable of shifting 36° (18° either side of the nominal position) in both the X and Y direction.

In Reduced protocol, the six outer modules are positioned as a unit. The **Master LED Function** channel allows you to enable all of the LED modules when the DMX value = 0-127 or disable the center Module when the DMX value = 128-187.

In Expanded protocol, the **Master LED X/Y Function** let's you enable X/Y positioning for all the modules as a unit with a DMX value = 0-127 or enable Independent X/Y Control with a DMX value = 128-187. With Independant X/Y control enabled, you set the module position using the **X** and **Y** parameters associated with each of the seven modules.

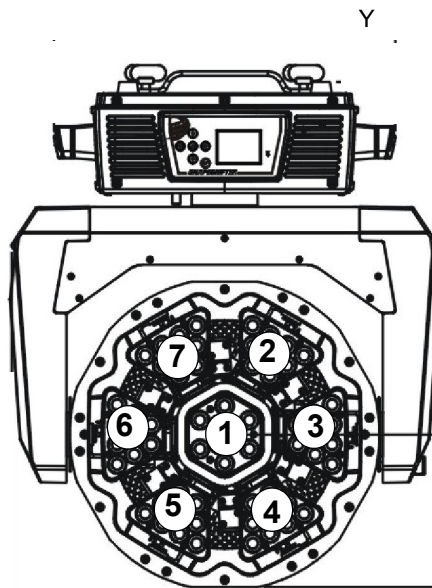
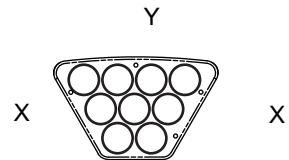

Color Parameters

Each Module of a SHAPESHIFTER fixture is composed of three groups of LEDs. In SHAPESHIFTER C1 fixtures, these are colored LEDs. When they are all set at the same intensity level, they project as white.

In SHAPESHIFTER W1 fixtures, the LEDs are still grouped but are all white.

The **LED Red**, **LED Green**, and **LED Blue** parameters control the saturation (brightness level) of each group of LEDs on a Module. Values for each color parameter range from **Off** when the DMX value = 0 to fully **On** when the DMX value = 255.

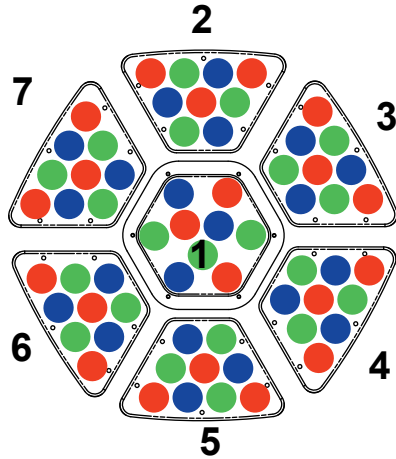

Reduced Protocol controls all the modules as a unit. For example, intensity set for one LED group will affect that group on each module.

Enhanced Protocol gives you control of each group of LEDs on a module independent of other modules.

The **Mix Color Function** parameter offers multiple options for controlling the LED color mixing and output. In Enhanced protocol mode, there is a **Mix Color Function** for each module.

Mix Color Function	DMX Value	Description
RGB	0-15	Mixes Red, Green and Blue
CMY	16-31	Mixes inverse of RGB . Red = Cyan, Green = Magenta, Blue = Yellow
Cycle	32-47	Cycles through all the colors. Red channel controls cycle speed from slow to fast
Random	48-63	Randomly selects color. Red channel controls intervals from slow to fast.

Note: *Mix Color Function parameters work the same for SHAPESHIFTER W fixtures but create effects in all white.*

Shutter Parameters

Shutter Function

The **Shutter Function** parameter control normal shutter and strobing features.

Shutter Options	DMX Value	Description
Normal Shutter Functions	0-23	Opens and closes shutter flags in the optical path
Random Random Strobe	24-299	Strobes beam at random intervals
Synchronous Random Strobe	230-255	Synchronizes random strobing for all SHAPESHIFTER fixtures using the same DMX controller

Shutter

The **Shutter** parameter determines sets the strobing rate.

DMX Value	Shutter Parameter Options
0-23	Close shutter
24-229	Set strobe rate from slowest to fastest
230-255	Open shutter

Dim

SHAPESHIFTER fixtures provide 16-bit brightness control utilizing the **Dim Coarse** and **Dim Fine** parameters. The dim values range from Off at a DMX value = 0 to fully on when the DMX value = 255 for both parameters.

MSpeed (Motor Speed)

MSpeed is the time required for a motor to complete movement when changing from one position to another. In SHAPESHIFTER fixtures, MSpeed provides a means for Pan and Tilt motors to reach their target position at the same time, even though each motor may have different distances to travel. MSpeed movement is extremely smooth because the fixture controls movements independent of DMX refresh rates.

MSpeed times vary from 0.15 seconds to 252.7 seconds. However, when MSpeed is applied to a parameter, the delay value (length of time allowed for the entire scene) needs to be longer than the MSpeed value to allow the motors to complete their movement before the end of the scene. An MSpeed value that is longer than the delay value could produce an undesirable result; for example, no light output during the scene. For a listing of exact MSpeed times, see *Chapter A: MSpeed Conversion Table* on page 57.

Macros

SHAPESHIFTER fixtures provides factory programmed multi-step macros to create a variety of looks without extensive user programming. Three Macro types give you varying levels of control over the look.

Note: *Inclusive Macros and Intensity Macros are designed to work with the fixture in RGB mode on the Mix Color Function channel. XY Macros do not contain color data.*

Inclusive Macros

The **Inclusive Macro** parameter contains Intensity, RGB, and Module X/Y, Speed, and Crossfade data that operate independently. The user can scale up or down from the preprogrammed speed and crossfade time for the macro.

Inclusive Macro Speed and **Inclusive Macro XFade** parameters allow you to scale the programmed speed and crossfade values of an Inclusive Macro.

DMX Value	Macro Speed and Macro XFade Channel Function
0	Stops playback or crossfade
1-127	Decreases playback speed / crossfade time from the programmed rate
128	Playbacks or cross fades speed is as programmed
129-255	Increases playback speed / crossfade time from the programmed rate

Note: *Depending on the programmed speed or crossfade values of an individual Inclusive Macro, some Speed and XFade values may not have an effect on the output.*

LED X Y and LED Intensity Macros

For more control of the final look of the macro, you can combine other Macro types. The **LED X Y Macro** parameter contains Module X/Y data only. The **LED Intensity Macro** parameter contains RGB Intensity data only. Each of these Macro types uses dedicated channels to control macro **Speed** and **Crossfade** in the following way.

DMX Value	Speed and Macro XFade Channel Function for LED XY or LED Intensity Macros
0-3	Stops playback or crossfade
4	Slowest playback speed or crossfade time
4-254	Increases the playback speed or crossfade time
255	Fastest playback speed or crossfade time

Control

The **Control** parameter allows remote control of Display, Homing, Module Lamp and Shutdown.

Note: *To access all control settings, first select a control channel value, then set the Shutter channel to DMX = 0.*

Control Setting	DMX Value	Description
Safe	0-5	Disables all Control settings for normal operation
Pan and Tilt MSpeed Off	16-31	Disables MSpeed
Display/LEDs Off	32-47	Turns display and all LED modules off
Display/LEDs Bright	48-63	Turns display and all LED modules fully on
Home All	64-79	Remotely homes all the fixture components
Shutdown	80-95	Remotely shuts down the fixture. When a fixture is shut down, the LEDs are off and power to the motors is disabled. If a fixture is in shutdown mode, the fixture must be homed to bring it back into operation.
Module X Invert On	112-127	This menu option inverts the direction of the Module X motor operation to coordinate movements between SHAPESHIFTER fixtures mounted opposite each other horizontally.
Module X Invert Off	128-143	
Module Y Invert On	144-159	This menu option inverts the direction of the Module Y motor operation to coordinate movements between SHAPESHIFTER fixtures mounted opposite each other vertically.
Module Y Invert Off	160-175	
Module XY Swap On	175-191	These options swap the Module X and Y motor operation to coordinate movements between SHAPESHIFTER fixtures mounted perpendicular to each other
Module XY Swap Off	192-207	

Indigo Highlighter

Indigo Highlighter system consists four 1-watt indigo LEDs that provide additional light output. Two parameters define the Indigo Highlighter operation.

Indigo Highlighter Function

You can choose to have the Indigo Highlighter system function independently from the fixture's dimming or track it.

Indigo Highlighter Function	DMX Value	Description
<i>Dim Tracking Mode</i>		
Continuous	0-15	Tracks the fixture dimming with continuous output
Periodic Strobe	16-41	Tracks the fixture dimming with periodic strobing from slowest to fastest
Random Strobe	42-67	Tracks the fixture dimming with random strobing from slowest to fastest
<i>Independent Tracking Mode</i>		
Continuous	128-143	Continuous output independent from fixture dimming
Periodic Strobe	144-169	Periodic strobing output independent from fixture dimming from slowest to fastest
Random Strobe	170-195	Periodic strobing output independent from fixture dimming from slowest to fastest

Indigo Highlighter Dim

This parameter adjusts the Indigo Highlighter LEDs from **Off** at a DMX value of 0 to fully **On** at a DMX value of 255.

Chapter 5:

General Maintenance and Troubleshooting

This chapter outlines safety and maintenance procedures as well as troubleshooting error messages.

Safety Considerations



CAUTION: The information in this chapter is intended to assist qualified personnel *only*.

Allow the fixture to cool before handling.



WARNING: To avoid electrical shock, disconnect power before servicing.

Maintenance

There are no serviceable parts inside the device . The following points have to be considered when inspecting the fixture for maintenance:

- All screws for installing the devices or parts of the device have to be tightly connected and must not be corroded.
- There must not be any deformations on the housing, color lenses, fixations and installation spots (ceiling, suspension, trussing).
- Mechanically moving parts must not show any traces of wearing and must not rotate with unbalances.
- The electric power supply cables must not show any damage, material fatigue or sediments.

Cleaning the Fixture

- Clean the outside of the lens each week to avoid the weakness of the lights due to accumulation of dust.
- A detailed electric check by approved electrical engineer each three month, make sure that the circuit contacts are in good condition to prevent overheating.

To clean fixture lens and components:

1. Disconnect power to the fixture. If the fixture has been operating, allow the fixture to cool before handling.
2. Clean using a moist, lint-free cloth. Never use alcohol or solvents.

Coplaner Alignment

Coplaner alignment allows the user to superimpose all seven beams and ensures that they all converge on the same area. The user adjusts each module after homing to be coplanar, selects coplaner alignment on the control channel, and these settings are stored into the fixture's non-volatile memory. On subsequent power cycles and homing, all seven beams are aligned, or coplanar.

This alignment is necessary to compensate for slight differences in focal position that will naturally happen with mechanical tolerances and homing tolerances. Note that the following example utilizes a HOG4 Lighting Console but

To reinstate coplaner alignment:

1. Set the fixture to **Enhanced Mode** in the menu system. Then, at the lighting console:
2. Patch the SHAPESHIFTER:
 - Add 1x SHAPESHIFTER master as fixture #1
 - Add 1x SHAPESHIFTER static module as fixture #2
 - Add 6x SHAPESHIFTER moving modules as fixtures #3-8.
3. Select fixtures 1 THRU 8, then press ENTER. This selects all fixtures
4. Working with the SHAPESHIFTER master, fixture #1, use PAN & TILT to position the light output from the fixture on a flat surface. We recommend that the surface be straight up, and perpendicular to the light output.
5. Under the MODE menu, select FIXTURE MODE INDEPENDENT. NOTE: This sets DMX channel 5 (MASTER LED X/Y Function) to a DMX value of 255. FIXTURE MODE INDEPENDENT allows for individual X/Y positioning of the moving modules.
6. Select the first moving module, Fixture #3, and use the LED X Pos and LED Y Pos encoders to adjust the position of the first moving module. Align the first moving module to form a single output superimposed over the static module output. NOTE: It may help if you move all 6 moving modules away from the center module initially.
7. Continue aligning all moving modules, fixtures #4-8, until all are convergent.
8. On HOG 4, Press SETUP then select the DMX button to open the DMX Output Window.
9. In the DMX Output Window, select DMX Channel 23 (Control Channel).
10. Press SET, and enter a DMX value of 96. Press ENTER, and hold that value for 3 seconds.
11. In the DMX Output Window, Select DMX Channel 23 (Control Channel).
12. Press SET and enter a DMX value of 0. Press ENTER.
13. The moving modules will home.
14. Release DMX channel 23 from the DMX Output Window by pressing the "Set to HobNet Input" button in the Dmx Output window.
15. Clear the programmer. The moving modules will now be aligned.

For other lighting consoles use the following steps:

1. Set the fixture to **Enhanced Mode** in the menu system. Then, at the controller:
2. Set channel 5 [Master LED X/Y Function] to DMX value 255
3. Adjust Channels 29, 30, 37, 38, 45, 46, 53, 54, 61, 62, 69 and 70 [X/Y Function on the modules] so that they are convergent
4. Set Channel 20 [Control] to DMX value 96 for 3 seconds
5. Set Channel 20 [Control] to DMX value 0. The module will home
6. Clear your Programmer, the modules will now all be aligned.

Troubleshooting Error Messages

When you turn on the fixture, it will make a reset at first. The display may show "Err channel is XX" while there are problems with one or more channels. "XX" stands for a channel with a testing sensor for positioning. For example, when the display shows "Err channel is Pan", it means there is some error in channel 1. If there are some errors on channel 1, channel 3, channel 32 at the same time, you may see the error message "Err channel is Pan movement", "Err channel is Tilt movement", "Err channel is LED2X" flash repeated for 2 times, and then the fixture will generate a second reset. If the fixture remain error message after performing reset more than 2 times, only the channels which have errors can not work properly, others can work as usual. Please contact with dealer or manufacturer for service, self repair is not allowed.

PAN- movement Er

(PAN-yoke movement error) This message will appear after the reset of the fixture if the yoke's magnetic-indexing circuit malfunction (sensor failed or magnet missing) or the stepping-motor is defective (or its driving IC on the main PCB). The PAN- movement is not located in the default position after the reset.

TILT- movement Er

(TILT-head movement error) This message will appear after the reset of the fixture if the head's magnetic-indexing circuit malfunctions (sensor failed or magnet missing) or the stepping-motor is defective (or its driving IC on the main PCB). The TILT- movement is not located in the default position after the reset.

LED2 X Er

(LED2 X - error) This message will appear after the reset of the fixture if the magnetic-indexing circuit malfunction (sensor failed or magnet missing) or the stepping-motor is defective (or its driving IC on the main PCB). The LED2 X is not located in the default position after the reset.

LED2 Y8 Er

(LED2 Y - error) This message will appear after the reset of the fixture if the magnetic-indexing circuit malfunction (sensor failed or magnet missing) or the stepping-motor is defective (or its driving IC on the main PCB). The LED2 Y is not located in the default position after the reset.

LED3 X Er

(LED3 X - error) This message will appear after the reset of the fixture if the magnetic-indexing circuit malfunction (sensor failed or magnet missing) or the stepping-motor is defective (or its driving IC on the main PCB). The LED3 X is not located in the default position after the reset.

LED3 Y Er

(LED3 Y -error) This message will appear after the reset of the fixture if the magnetic-indexing circuit malfunction (sensor failed or magnet missing) or the stepping-motor is defective (or its driving IC on the main PCB). The LED3 Y is not located in the default position after the reset.

LED4 X Er

(LED4 X -error) This message will appear after the reset of the fixture if the magnetic-indexing circuit malfunction (sensor failed or magnet missing) or the stepping-motor is defective (or its driving IC on the main PCB). The LED4 X is not located in the default position after the reset.

LED4 Y Er

(LED4 Y - error) This message will appear after the reset of the fixture if the magnetic-indexing circuit malfunction (sensor failed or magnet missing) or the stepping-motor is defective (or its driving IC on the main PCB). The LED4 Y is not located in the default position after the reset.

LED5 X Er

(LED5 X -error) This message will appear after the reset of the fixture if the magnetic-indexing circuit malfunction (sensor failed or magnet missing) or the stepping-motor is defective (or its driving IC on the main PCB). The LED5 X is not located in the default position after the reset.

LED5 Y Er

(LED5 Y - error) This message will appear after the reset of the fixture if the magnetic-indexing circuit malfunction (sensor failed or magnet missing) or the stepping-motor is defective (or its driving IC on the main PCB). The LED5 Y is not located in the default position after the reset.

LED6 X Er

(LED6 X -error) This message will appear after the reset of the fixture if the magnetic-indexing circuit malfunction (sensor failed or magnet missing) or the stepping-motor is defective (or its driving IC on the main PCB). The LED6 X is not located in the default position after the reset.

LED6 Y Er

(LED6 Y - error) This message will appear after the reset of the fixture if the magnetic-indexing circuit malfunction (sensor failed or magnet missing) or the stepping-motor is defective (or its driving IC on the main PCB). The LED6 Y is not located in the default position after the reset.

LED7 X Er

(LED7 X -error) This message will appear after the reset of the fixture if the magnetic-indexing circuit malfunction (sensor failed or magnet missing) or the stepping-motor is defective (or its driving IC on the main PCB). The LED7 X is not located in the default position after the reset.

LED7 Y Er

(LED7 Y - error) This message will appear after the reset of the fixture if the magnetic-indexing circuit malfunction (sensor failed or magnet missing) or the stepping-motor is defective (or its driving IC on the main PCB). The LED7 Y is not located in the default position after the reset.

Appendix A:

MSpeed Conversion Table

The following table lists the MSpeed (motor) movement times and their corresponding DMX controller values. If you have a numeric-type controller, use the Value Decimal (dec.) column. If you have a fader-type controller, use the Value Percentage (%) column. If your controller allows you to program hex values, use the Value (hex) column.

Time (sec.)	Value (dec.)	Value (%)	Value (hex)	Time (sec.)	Value (dec.)	Value (%)	Value (hex)	Time (sec.)	Value (dec.)	Value (%)	Value (hex)
0.15	255	100	FF	5.94	217	85	D9	23.30	179	70	B3
0.15	254	100	FE	6.25	216	85	D8	23.92	178	70	B2
0.17	253	99	FD	6.56	215	84	D7	24.54	177	69	B1
0.19	252	99	FC	6.89	214	84	D6	25.17	176	69	B0
0.21	251	98	FB	7.22	213	84	D5	25.80	175	69	AF
0.25	250	98	FA	7.56	212	83	D4	26.45	174	68	AE
0.29	249	98	F9	7.91	211	83	D3	27.10	173	68	AD
0.35	248	97	F8	8.27	210	82	D2	27.76	172	67	AC
0.41	247	97	F7	8.63	209	82	D1	28.43	171	67	AB
0.47	246	96	F6	9.00	208	82	D0	29.11	170	67	AA
0.55	245	96	F5	9.39	207	81	CF	29.80	169	66	A9
0.63	244	96	F4	9.77	206	81	CE	30.49	168	66	A8
0.73	243	95	F3	10.17	205	80	CD	31.19	167	65	A7
0.83	242	95	F2	10.58	204	80	CC	31.90	166	65	A6
0.94	241	95	F1	10.99	203	80	CB	32.62	165	65	A5
1.05	240	94	F0	11.41	202	79	CA	33.34	164	64	A4
1.18	239	94	EF	11.84	201	79	C9	34.08	163	64	A3
1.31	238	93	EE	12.28	200	78	C8	34.82	162	64	A2
1.45	237	93	ED	12.72	199	78	C7	35.57	161	63	A1
1.60	236	93	EC	13.17	198	78	C6	36.33	160	63	A0
1.75	235	92	EB	13.63	197	77	C5	37.09	159	62	9F
1.92	234	92	EA	14.10	196	77	C4	37.87	158	62	9E
2.09	233	91	E9	14.58	195	76	C3	38.65	157	62	9D
2.27	232	91	E8	15.07	194	76	C2	39.44	156	61	9C
2.46	231	91	E7	15.56	193	76	C1	39.44v	156	61	9C
2.66	230	90	E6	16.06	192	75	C0	40.23	155	61	9B
2.86	229	90	E5	16.57	191	75	BF	41.04	154	60	9A
3.07	228	89	E4	17.09	190	75	BE	41.85	153	60	99
3.29	227	89	E3	17.61	189	74	BD	42.68	152	60	98
3.52	226	89	E2	18.14	188	74	BC	43.50	151	59	97
3.76	225	88	E1	18.68	187	73	BB	44.34	150	59	96
4.00	224	88	E0	19.23	186	73	BA	45.19	149	58	95
4.25	223	87	DF	19.79	185	73	B9	46.04	148	58	94
4.52	222	87	DE	20.36	184	72	B8	46.90	147	58	93
4.78	221	87	DD	20.93	183	72	B7	47.77	146	57	92
5.06	220	86	DC	21.51	182	71	B6	48.65	145	57	91
5.34	219	86	DB	22.10	181	71	B5	49.54	144	56	90
5.64	218	85	DA	22.70	180	71	B4	50.43	143	56	8F

Time (sec.)	Value (dec.)	Value (%)	Value (hex)	Time (sec.)	Value (dec.)	Value (%)	Value (hex)	Time (sec.)	Value (dec.)	Value (%)	Value (hex)
51.33	142	56	8E	102.77	95	37	5F	175.24	46	18	2E
52.24	141	55	8D	104.05	94	37	5E	176.92	45	18	2D
53.16	140	55	8C	105.35	93	36	5D	178.61	44	17	2C
54.09	139	55	8H	106.65	92	36	5C	180.30	43	17	2B
55.02	138	54	8A	107.96	91	36	5B	182.01	42	16	2A
55.96v	137	54	89	109.28	90	35	5A	183.72	41	16	29
56.91	136	53	88	110.61	89	35	59	185.44	40	16	28
57.87	135	53	87	111.94	88	35	58	187.17	39	15	27
58.84	134	53	86	113.28	87	34	57	188.90	38	15	26
59.81	133	52	85	114.63	86	34	56	190.65	37	15	25
60.79	132	52	84	115.99	85	33	55	192.40	36	14	24
61.78	131	51	83	117.36	84	33	54	194.16	35	14	23
62.78	130	51	82	118.73	83	33	53	195.92	34	13	22
63.79	129	51	81	120.12	82	32	52	197.70	33	13	21
64.80	128	50	80	121.5v	81	32	51	199.48	32	13	20
65.82	127	50	7F	122.91	80	31	50	201.28	31	12	1F
66.85	126	49	7E	124.31	79	31	4F	203.08	30	12	1E
67.89	125	49	7D	125.73	78	31	4E	204.88	29	11	1D
68.94	124	49	7C	127.15	77	30	4D	206.70	28	11	1C
69.99	123	48	7B	128.58	76	30	4C	208.52	27	11	1B
71.05	122	48	7A	130.02	75	29	4B	210.36	26	10	1A
72.13	121	47	79	134.39	72	28	48	212.19	25	10	19
73.20	120	47	78	135.86	71	28	47	214.04	24	9	18
74.29	119	47	77	137.34	70	27	46	215.90	23	9	17
75.38	118	46	76	138.82	69	27	45	217.76	22	9	16
76.49	117	46	75	140.32	68	27	44	219.63	21	8	15
77.60	116	45	74	141.82	67	26	43	221.51	20	8	14
78.71	115	45	73	143.33	66	26	42	223.40	19	7	13
79.84	114	45	72	144.85	65	25	41	225.30	18	7	12
80.98	113	44	71	146.38	64	25	40	227.20	17	7	11
82.12	112	44	70	147.92	63	25	3F	229.11	16	6	10
83.27	111	44	6F	149.46	62	24	3E	231.03	15	6	0F
84.43	110	43	6E	151.01	61	24	3D	232.96	14	5	0E
85.59	109	43	6D	152.57	60	24	3C	234.90	13	5	0D
86.77	108	42	6C	154.14	59	23	3B	236.84	12	5	0C
87.95	107	42	6B	155.71	58	23	3A	238.79	11	4	0B
89.14	106	42	6A	157.30	57	22	39	240.75	10	4	0A
90.34	105	41	69	158.89	56	22	38	242.72	9	4	09
91.55	104	41	68	160.49	55	22	37	244.70	8	3	08
92.76	103	40	67	162.09	54	21	36	246.68	7	3	07
93.98	102	40	66	163.71	53	21	35	248.68	6	2	06
95.21	101	40	65	165.33	52	20	34	250.68	5	2	05
96.45	100	39	64	166.96	51	20	33	246.68	7	3	07
97.70	99	39	63	168.60	50	20	32	248.68	6	2	06
98.95	98	38	62	170.25	49	19	31	250.68	5	2	05
100.22	97	38	61	171.91	48	19	30	252.68	4	2	04
101.49	96	38	60	173.57	47	18	2F				